



Fischer Panda®

Power wherever
you are™

Fischer Panda 20kW 48V 600rpm drive

Technical specifications:

Voltage: 48V
Input power: 22 kW
Shaft power: 20 kW
RPM: 600
Nm: 320
Weight: 96kg

Art-No: 0015607

Our shaft motors are made of heavy duties and have a double-walled aluminum housing which is water-cooled with integrated thrust bearings.

They are without gear, brushless, sensorless and have no oil filling.

This makes our engines: durable, efficient and low maintenance!

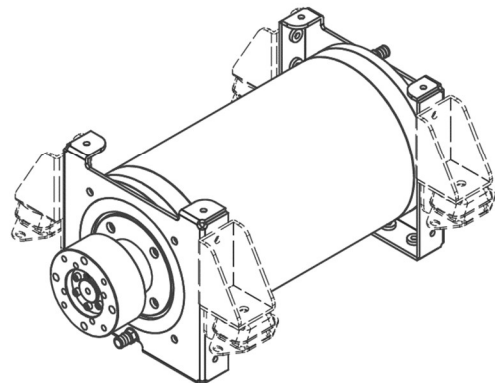
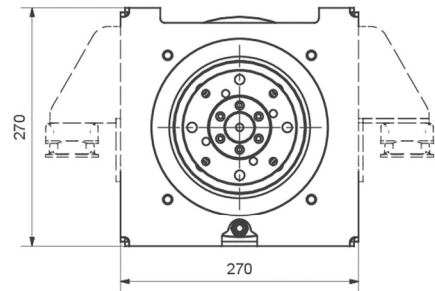
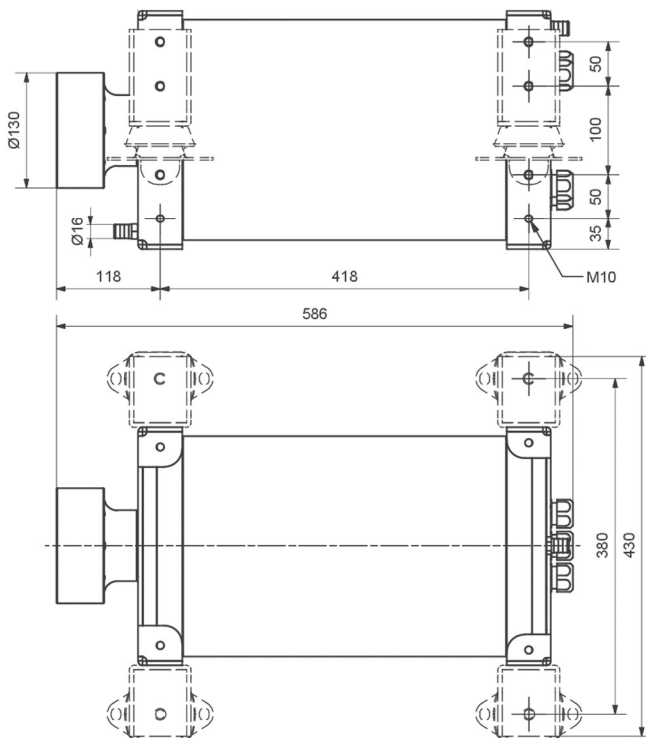

Fischer Panda GmbH
Otto - Hahn - Str.40
33104 Paderborn
Germany

contact person:
Martin Mews
Gerhard Hesse
Marcel Schwarzenberg-U.

+49 5254 9202-350
+49 5254 9202-238
+49 5254 9202-352

mmews@fischerpanda.de
ghesse@fischerpanda.de
mschwarzenberg@fischerpanda.de